

Camera 335B Visual Presenter

User's Guide



UG335B122209V1

Contents

Chapter 1 Precautions	3
Safety Precautions	4
FCC Warning.....	4
Chapter 2 Package Contents.....	5
Chapter 3 Product Overview	6
3.1 Positioning the Presenter and Document.....	7
3.2 Correct Usage	7
Chapter 4 Installation and Connections	8
4.1 System Diagram	8
4.2 Connecting to External Devices	9
4.3 Getting Started.....	11
Chapter 5 DIP Switch	12
5.1 Connecting to a Projector or Monitor	12
5.2 Connecting to a TV.....	13
Chapter 6 Introduction to Control Panel/ Remote Control Buttons and On-Screen Menu	14
6.1 Functions of Control Panel and Remote Control Buttons	14
6.2 On-screen Menu.....	15
Chapter 7 Descriptions of Major Functions.....	17
7.1 Switching Image Sources.....	17
7.2 Making Text Clearer and Photos More Colorful	17
7.3 Zoom in /out From an Image	17
7.4 Using Auto Focus	17
7.5 Adjusting the Brightness.....	17

7.6	Turning the Lamp on/off	18
7.7	Automatically Adjusting the Image to Optimal Brightness and Focal Length 18	
7.8	Freezing Images.....	18
7.9	Capturing Images	18
7.10	Browsing Captured Images	18
7.11	Deleting Captured Images.....	19
7.12	Automatically Deleting Captured Images When the Device is Turned off (Auto Erase)	19
7.13	Panning Across a Live Image (PAN)	20
7.14	Playing a Slides (Slide Show)	20
7.15	Comparing Live Images with Stored Images (PBP).....	21
7.16	Restoring Factory Default Settings (Factory Reset).....	22
7.17	Computer- Related Functions	22
7.17.1	Inserting a Photo in the MS-Paint Application.....	23
7.17.2	Inserting a Photo in a Microsoft Word Document	23
7.17.3	Changing the Setting of the Camera 335B and then Capturing a Photo in Microsoft Word	24
7.17.4	Setting up the Camera 335B as a Webcam for <i>Skype</i>	25
7.17.5	Setting the Camera 335B as a PC Camera.....	27
Chapter 8	Connecting to a Microscope	28
Chapter 9	Software instructions	29
9.1	System Requirements	29
9.2	Installation & Function	29
Chapter 10	Troubleshooting.....	30

Chapter 1 Precautions

Always follow these safety instructions when setting up and using the Document Camera:

1. Please do not tilt the machine while using.
2. Do not place the Document Camera on an unstable trolley, stand or table.
3. Do not use the Document Camera near water or source of heat.
4. Use attachments only as recommended.
5. Use the type of power source indicated on the Document Camera. If you are not sure of the type of power available, consult your dealer or local electricity company for advice.
6. Place the Document Camera where it can be easily unplugged.
7. Always take the following precautions when handling the plug. Failure to do so may result in sparks or fire.
 - Ensure the plug is free of dust before inserting it into a socket.
 - Ensure that the plug is inserted into the socket securely.
8. Do not overload wall sockets, extensions leads or multi-way plug boards as this may cause fire or electric shock.
9. Do not place the Document Camera where the cord can be stepped on as this may result in fraying or damage to the lead or the plug.
10. Unplug the projector from the wall socket before cleaning. Use a damp cloth for cleaning. Do not use liquid or aerosol cleaners.
11. Do not block the slots and openings in the case. They provide ventilation and prevent the Document Camera from overheating. Do not place the Document Camera on a sofa, rug or other soft surface or in a built-in installation unless proper ventilation is provided.
12. Never push objects of any kind through cabinet slots. Never allow liquid of any kind to spill into the Document Camera.
13. Except as specifically instructed in this User's Manual, do not attempt to operate this product by yourself. Opening or removing covers may expose you to dangerous voltages and other hazards. Refer all servicing to licensed service personnel.
14. Unplug the Document Camera during thunderstorms or if it is not going to be used for an extended period, do not place the Document Camera or remote control on top of heat-emitting equipment or heated objects such as a car and etc.
15. In the following situations, unplug the Document Camera from the wall outlet and refer servicing to licensed service personnel:
 - If the power cable or plug becomes damaged or frayed.





- If liquid is spilled into it or the Document Camera has been exposed to rain or water.

● Safety Precautions

Warning: To reduce the risk of fire or electric shock, do not expose this appliance to rain or moisture.

This Document Camera has a 3-wire AC line Plug. This is a safety feature to ensure that the plug will fit into the power outlet. Do not try to defeat this safety feature.

If the Document Camera will not be used for an extended time, unplug it from the power outlet.

	<table border="1"> <tr> <td style="text-align: center;">CAUTION</td> </tr> <tr> <td style="text-align: center;">RISK OF ELECTRIC SHOCK</td> </tr> </table>	CAUTION	RISK OF ELECTRIC SHOCK	
CAUTION				
RISK OF ELECTRIC SHOCK				
<p>Caution: To reduce the risk of electric shock. Do not remove the cover (or back). No user-serviceable parts inside. Refer servicing to licensed service Personnel.</p>				
	<p>This symbol indicates that dangerous voltage constituting a risk of electric shock is present within this unit.</p>			
		<p>This symbol indicates that there are important operating and maintenance instructions in this User's Manual with this unit.</p>		

● FCC Warning

This Document Camera has been certified to comply with the limits for a Class A computing device, pursuant to Subpart J of Part 15 of FCC Rules. These limits are designed to provide reasonable protection against a harmful interference when the equipment is operated in a commercial environment.

Chapter 2 Package Contents

Camera 335B



User Guide

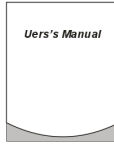

CD



Remote Control



Warranty Card



VGA Cable



USB Cable

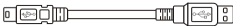

C-Video Cable



Power Cord

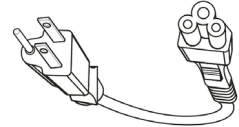

Appearance may vary in different countries

Chapter 3 Product Overview

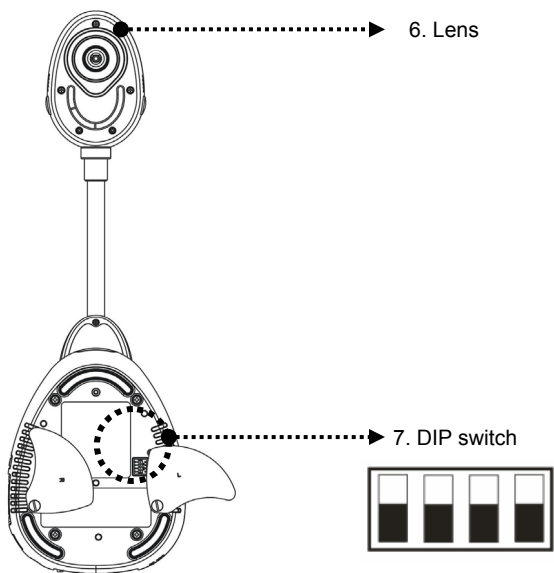
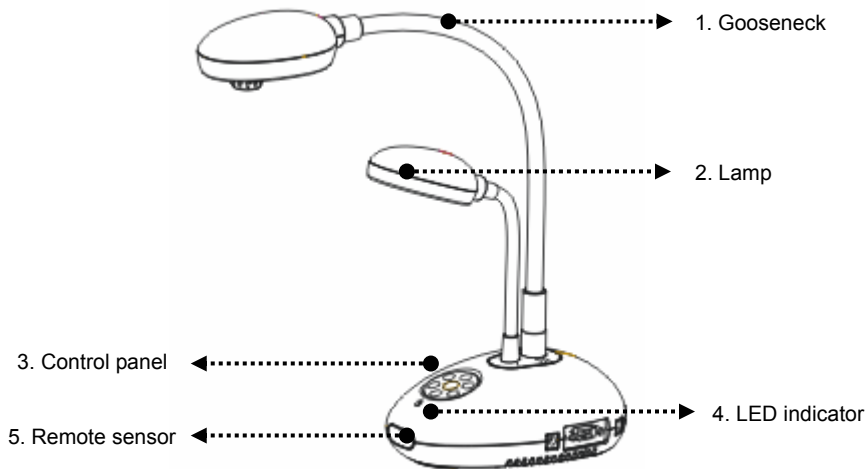

3.1 Positioning the Presenter and Document

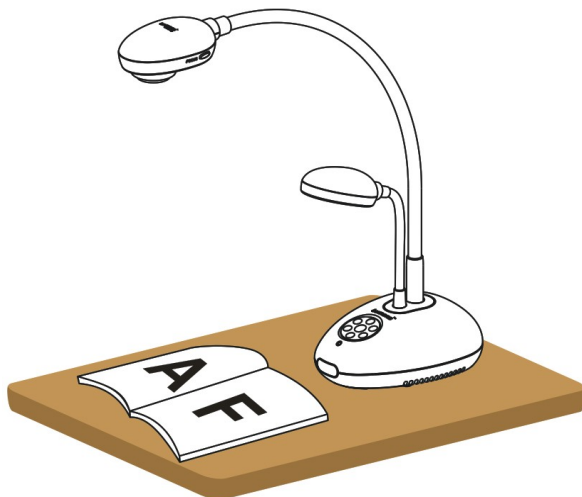

3.2 Correct Usage

* About 400mm distance between camera and the desktop is recommended.

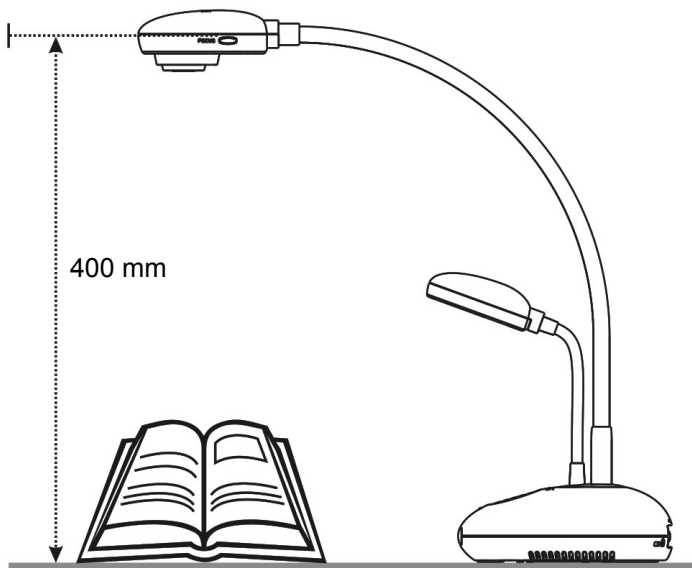

Chapter 4 Installation and Connections

4.1 System Diagram

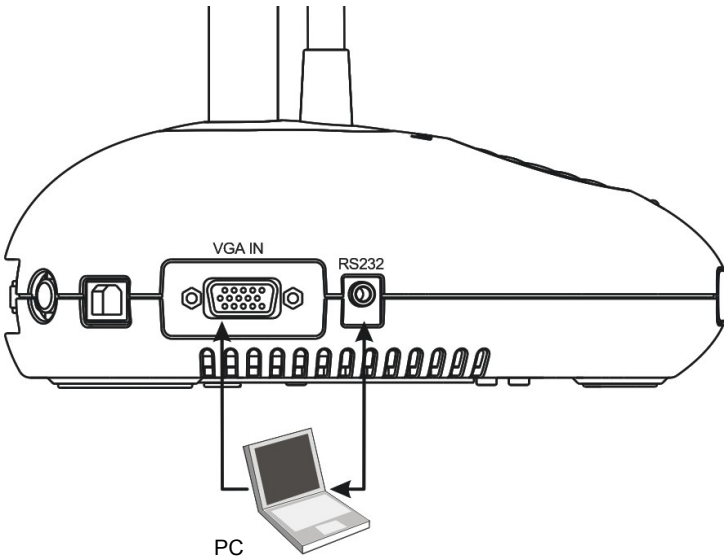
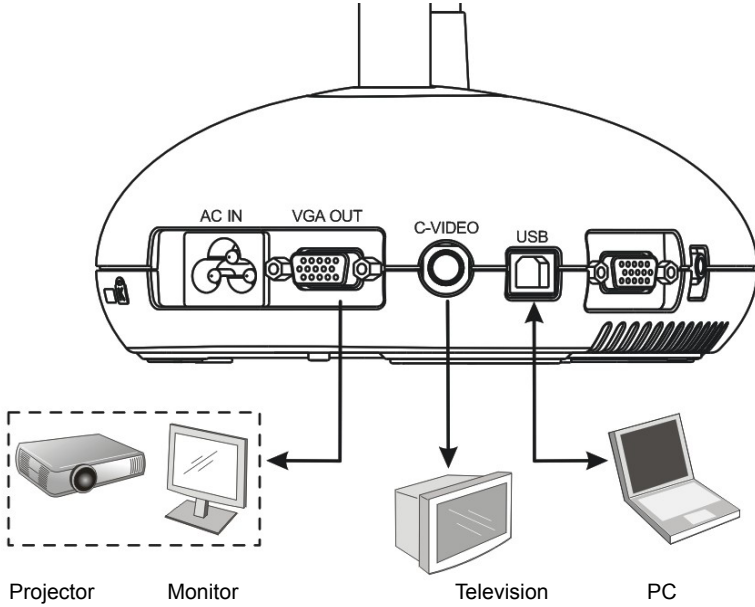

4.2 Connecting to External Devices

4.2.1 Step 1: Connect the power cord from the AC In on the Camera 335B to the power outlet

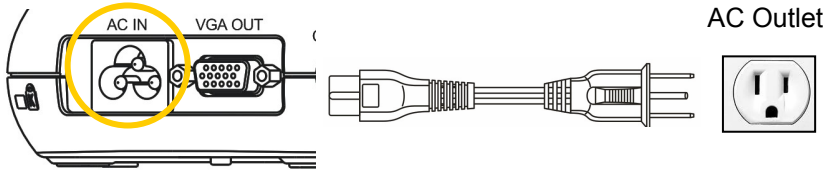

<Note>: Appearance of the power cord may vary depending on country/region.

4.2.2 Step 2: Connection projector with other hardware devices

➤ Connecting to a Projector or Monitor

- Connect the VGA cable from the VGA OUT port on the Camera 335B to the VGA IN port on the projector or monitor.

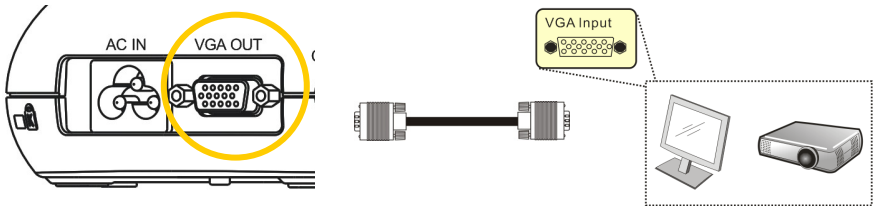

➤ Connecting to a TV

1. Connect the C-VIDEO cable from the C-VIDEO port on the Camera 335B to the C-VIDEO port on the TV.

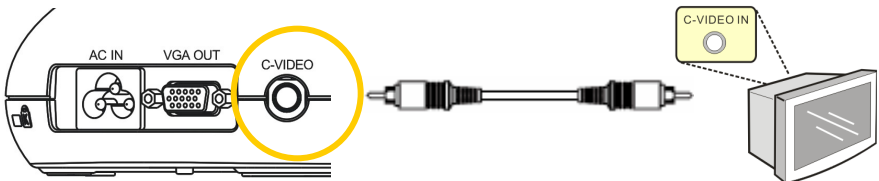

2. Adjust DIP Switch Setting

- NTSC: U.S.A., Taiwan, Panama, Philippine, Canada, Chile, Japan, Korea and Mexico.

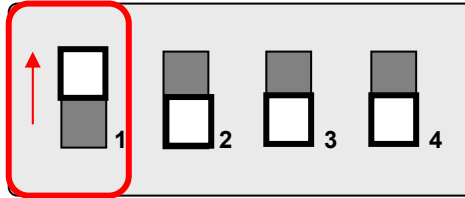

- PAL: Country/region not listed above.

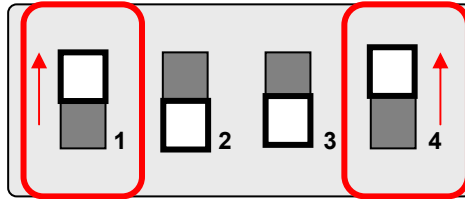

<Note> The on-screen display (OSD) is not available in C-VIDEO. Some functions are not available on the control panel and the remote control in this mode.

<Note> VGA OUT is not supported once C-VIDEO is enabled.

3. DIP switch settings will not available until the Camera 335B has been restarted.

➤ Connecting to a Computer

1. Connect the USB cable from the USB port on the Camera 335B to the USB port on the computer.

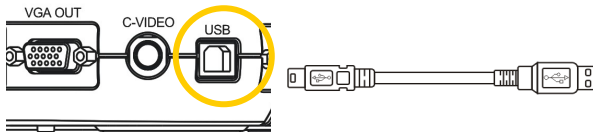

2. Connect the VGA cable from the VGA IN port on the Camera 335B to the VGA OUT port on the computer.

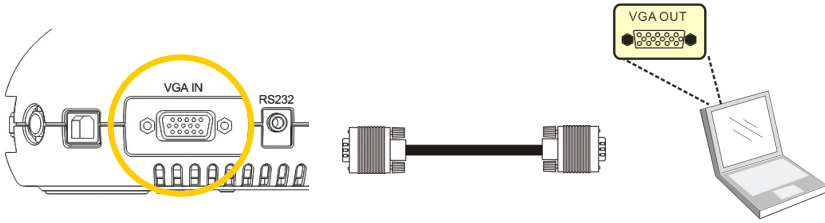

3. Connect the RS-232 Adapter (Optional) to the RS-232 port on the Camera 335B and the RS-232 port on the computer.

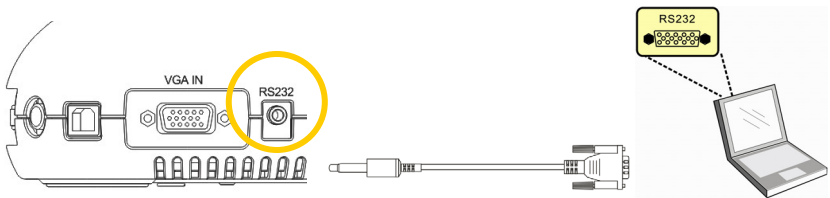

4.3 Getting Started

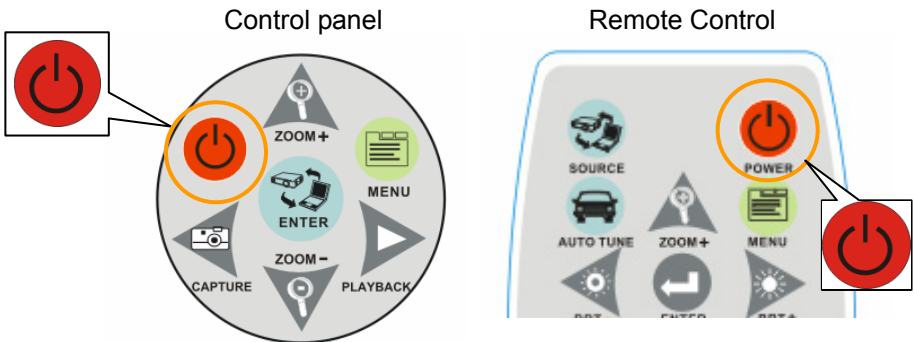

- To turn on the Camera 335B with the **remote control**, aim at the remote sensor at the Camera 335B and press the Power button.
- Once the Camera 335B is powered on, the LED on the projector will flash a few times and then remain lit. Contact your distributor if the LED fails to light.

Chapter 5 DIP Switch

<Note>: You must restart the Camera 335B in order for DIP switch configuration to take effect.

5.1 Connecting to a Projector or Monitor

5.1.1 SXGA output (factory default):

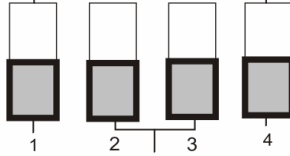

5.1.2 WXGA output

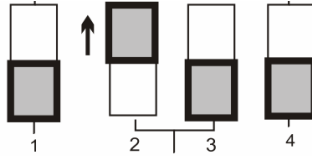

5.1.3 XGA output

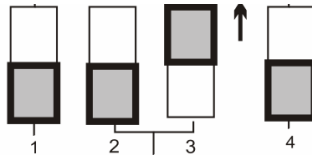

5.1.4 Special mode

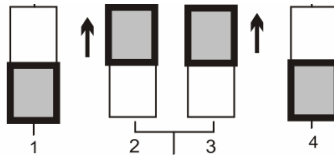

5.2 Connecting to a TV

5.2.1 NTSC Settings: U.S.A., Taiwan, Panama, Philippines, Canada, Chile, Japan, Korea, and Mexico

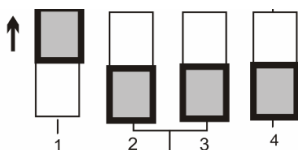

5.2.2 PAL Settings: Countries/regions not listed above

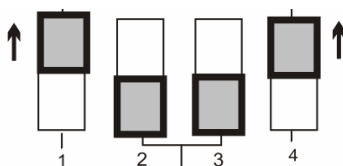

<Note> VGA OUT is not supported once C-VIDEO is enabled.

Chapter 6 Introduction to Control Panel/ Remote Control Buttons and On-Screen Menu

6.1 Functions of Control Panel and Remote Control Buttons

<Remark> The functions below are listed alphabetically

Name	Function Descriptions	Operation
	Turns the visual presenter on and off.	Remote control / Control panel
◀, ▶, ▲, ▼	Moves up, down, left or right to select the needed function.	Remote control / Control panel
AF	Automatically adjusts the focal length between the lens and the object being projected.	Either side of the unit's lens
AUTO TUNE	Automatically adjusts to the optimal brightness and focal length.	Remote Control
BRT+/-	Adjusts brightness of the image.	Remote Control
CAPTURE	Captures the image to the internal memory.	Remote control / Control panel
DELETE	Deletes images stored in the internal memory.	Remote Control
ENTER	Accesses/Activates functions.	Remote control / Control panel
FREEZE	Freezes the current image temporarily on the screen. Press again to unfreeze.	Remote Control
MENU	Activates the on-screen menu/exits the menu.	Remote control / Control panel
PAN	Moves across part of the live image.	Remote Control
PBP	Allows users to compare live images with captured image files.	Remote Control
PLAYBACK	Plays captured images.	Remote control / Control panel
ROTATE	Rotates the image by 0°/90°/180°/270°	Remote Control
SLIDE SHOW	Plays the photos in a slide show.	Remote Control
SOURCE	Switches between different image sources: 1. Live images (default). 2. PC.	Remote control / Control panel
ZOOM +/-	Increases or decreases image size.	Remote control / Control panel

6.2 On-screen Menu

<Note> Press [**Menu**] on the **remote control** or **control panel** to enter the on-screen menu, **The bold underlined values in the following table are defaults.**

1st Level Major Items	2nd Level Sub items	3rd Level Adjustment Values	Function Descriptions
Display	Auto Tune	Enter	Press [ENTER] to automatically adjust to the optimal brightness and focal length.
	Focus	0~Max	Use the left and right arrow keys to adjust focal length.
	Mode	<u>Normal</u> /Slide/Film/Microscope	Use the left and right arrow keys to select the image mode.
	Photo/Text	<u>Photo</u> /Text/Gray	Use the left and right arrow keys to select the photo/text/gray mode.
	PBP	Enter	Press [ENTER] to immediately activate the image comparison mode.
	PAN	ON / <u>OFF</u>	Use the left and right arrow keys to move across the live image.
	Rotate	<u>0°</u> /90°/180°/270°	Use the left and right arrow keys to rotate the image.
Storage	Slide Show	Enter	Press [ENTER] to play the photos stored in the internal memory in slide show mode.
	Slide Show Effect	<u>Off</u> /Shutter/Right/Down/Side/Open	Use the left and right arrow keys to select a page-flipping mode.
	Delay	<u>1 Sec</u> /3 Sec/5 Sec/10 Sec/ Manual	Use the left and right arrow keys to select the timing of page flips. (Select manual mode to switch images manually.)
	Delete All	Yes/ <u>No</u>	Use the left and right arrow keys to select desired image, and then press [ENTER] to confirm the deletion of the photo.
	Format	Yes/ <u>No</u>	Use the left and right arrow keys to select, and then format the internal memory.

	Auto Erase	ON/ <u>OFF</u>	Use the left and right arrow keys to enable/disable the auto erase function, which automatically deletes all stored images upon system shutdown.
Setting	USB Transfer	<u>Camera</u> /Storage Device	Use the left and right arrow keys to select the USB transfer mode.
	Lamp	<u>ON</u> /OFF	Use the left and right arrow keys to turn the lamp on/off.
	AE	<u>ON</u> /OFF	Use the left and right arrow keys to turn the Auto Erase (AE) on/off.
	AWB	Enter	Press [ENTER] to activate Automatic White Balance (AWB) immediately.
	Night Vision	ON / <u>OFF</u>	Use the left and right arrow keys to select the night vision mode.
Advance	Language	<u>English</u> /繁體中文 /Deutsch/Français/ Español/Русский/ Nederlands/Suomi/ Polski	Use the left and right arrow keys to select the preferred language.
	Preset Load	Yes/ <u>No</u>	Read the value of the current image mode. Use the left and right arrow keys to select, and then confirm by pressing [ENTER].
	Preset Save	Yes/ <u>No</u>	Store the value of the current image mode. Use the left and right arrow keys to select, and then confirm by pressing [ENTER].
	Factory Reset	Yes/ <u>No</u>	Use the left and right arrow keys to select, and then confirm by pressing [ENTER] to restore factory defaults.

Chapter 7 Descriptions of Major Functions

7.1 Switching Image Sources

Live image is the default image source. Press [SOURCE] on the **remote control** or **control panel** to switch between image sources:

1. Live images (default).
2. PC.

7.2 Making Text Clearer and Photos More Colorful

Photo (**Photo mode**) is selected by default in the [Photo/Text/Gray] mode

- [Photo] (Default): View photos or text with photos in this mode to enhance colors in photos.
- [Text]: View text files in this mode to make text clearer.
- [Gray]: View grayscale or black and white photos in this mode.

Change settings with the **remote control** or **control panel**:

1. Press [MENU] to enter the on-screen menu.
2. Press [▶] or [◀] to select [Display].
3. Press [▼] to select among [Photo/Text/Gray] modes. (Refer to the [description above](#) for the best choice).
4. Press [▶] or [◀] to move among [Photo/Text/Gray] modes.
5. Press [MENU] to exit.

7.3 Zoom in /out From an Image

1. Press [ZOOM+] on the **remote control** or **control panel** to zoom in to an image.
2. Press [ZOOM-] on the **remote control** or **control panel** to zoom out from an image.

7.4 Using Auto Focus

1. From the **Control Panel**, press the [FOCUS] button on the right side of the lens.

7.5 Adjusting the Brightness

1. From the **Remote Control** or **Control Panel**, press [BRT+] to make it

brighter.

2. From the **Remote Control** or **Control Panel**, press [BRT-] to darken the image.

7.6 Turning the Lamp on/off

From the **remote control** or **control panel**:

1. Press [MENU] to enter the on-screen menu.
2. Press [▶] or [◀] to select [Setting].
3. Press [▼] to select [Lamp] modes.
4. Press [▶] or [◀] to turn [ON]/[OFF].
5. Press [MENU] to exit.

7.7 Automatically Adjusting the Image to Optimal Brightness and Focal Length

From the remote control:

1. Press [AUTO TUNE] for the optimal brightness and focal length.

From the control panel:

1. Press [MENU] to enter the on-screen menu.
2. Press [▶] or [◀] to select [Display].
3. Press [▼] to select among [Auto Tune] modes.
4. Press [ENTER].
5. Press [MENU] to exit.

7.8 Freezing Images

1. Press [FREEZE] on the **remote control** to freeze the current image on the screen. Press again to unfreeze.

7.9 Capturing Images

1. Press [CAPTURE] on the **remote control** or **control panel** to capture and save an image.

7.10 Browsing Captured Images

1. Press [PLAYBACK] on the **remote control** or **control panel** to display thumbnails of all captured images.

2. Press [▲] or [▼] or [◀] or [▶] to select the thumbnail you want you browse.
3. Press [ENTER] to access the full-screen display of the image.
4. Press [▶] or [◀] to browse the through saved images.
5. Press [PLAYBACK] to exit.
6. Press [MENU] to exit.

7.11 Deleting Captured Images

From the remote control:

1. Press [PLAYBACK].
2. Press [▲] or [▼] or [◀] or [▶] to select the desired thumbnail for deletion.
3. Press [DELETE] to delete the selected file.
4. Press [MENU] to exit.

From the control panel:

1. Press [MENU] to enter the on-screen menu.
2. Press [▶] or [◀] to select [Storage].
3. Press [▼] to select [Delete All].
4. Press [▶] or [◀] to select [Yes].
5. Press [ENTER] to confirm selection.
6. Press [MENU] to exit.

7.12 Automatically Deleting Captured Images When the Device is Turned off (Auto Erase)

From the remote control or control panel:

1. Press [MENU] to enter the on-screen menu.
2. Press [▶] or [◀] to access the [Storage] menu.
3. Press [▲] or [▼] to enable [Auto Erase].
4. Press [▶] or [◀] to select among [ON] modes.
5. Press [MENU] to exit.

7.13 Panning Across a Live Image (PAN)

<Note> Panning and zooming are not available in Microscope Mode.

From the remote control:

1. Press [PAN] on the **remote control** to zoom in a part of a live image.
2. Press [▲] or [▼] or [◀] or [▶] to move around the partially zoomed-in image.
3. Press [PAN] to exit the partially zoom in mode.

From the control panel:

1. Press [MENU] to enter the on-screen menu.
2. Press [▶] or [◀] to select the [Display] menu.
3. Press [▼] to select [PAN].
4. Press [▶] or [◀] to select among [ON] modes.
5. Press [MENU] to exit.
6. Press [▲] or [▼] or [◀] or [▶] to move around the partially zoomed-in image.

7.14 Playing a Slides (Slide Show)

7.14.1 Using the slide show effect:

1. Press [MENU] on the **remote control** or **control panel** to enter the on-screen menu.
2. Press [▶] or [◀] to select the [Storage] menu.
3. Press [▼] to enable [Slide Show Effect].
4. Press [▶] or [◀] to select page-flipping mode among [Off / Shutter / Right / Down / Side / Open].
5. Press [MENU] to exit.

7.14.2 Setting delay time

1. Press [MENU] on the **remote control** or **control panel** to enter the on-screen menu.
2. Press [▶] or [◀] to select the [Storage] menu.
3. Press [▼] to enable [Delay].
4. Press [▶] or [◀] to select page-flipping interval [1 Sec/3 Sec/5 Sec/10 Sec/Manual].
5. Press [MENU] to exit.

7.14.3 Start/Pause/Stop Playing Images

<Note> Images over 8MB cannot be played. During playback, the [ROTATE] function can be activated to rotate the images.

From the remote control:

1. Press [SLIDE SHOW] to start playback.
2. Press [ENTER] to pause playback.
3. Press [ENTER] again to continue playback.
4. Press [SLIDE SHOW] again to stop playback.

From the control panel:

1. Press [MENU] to enter the on-screen menu.
2. Press [▶] or [◀] to select the [Storage] menu.
3. Press [▼] to enable [Slide Show].
4. Press [ENTER] to play back images.
5. Press [ENTER] to pause playback.
6. Press [ENTER] again to continue playback.
7. To stop playing, repeat Steps 1 to 4.

7.15 Comparing Live Images with Stored Images (PBP)

This function allows you to simultaneously display a live image on the right side and a storage image on the left side for comparison.

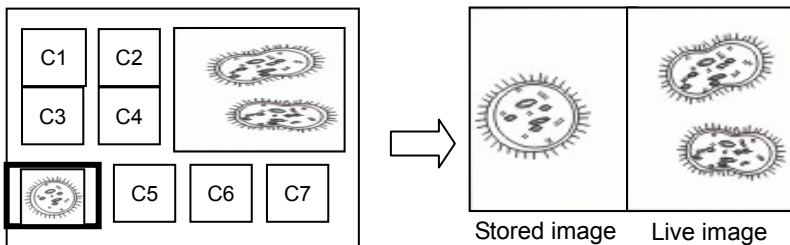

From the remote control:

1. Press [PBP] to enter the photo selection screen.
2. Press [▲] or [▼] or [◀] or [▶] to select the file to be compared.
3. Press [ENTER] to activate image comparison.
4. Press [ENTER] to switch between the stored image and the live image.

5. Press [▶] or [◀] to move the selected image left or right.
6. Press [ZOOM+/-] to zoom in/out from the live image
7. Press [PBP] to return to the stored image screen.
8. Press [MENU] to exit.

From the control panel

1. Press [MENU] to enter the on-screen menu.
2. Press [▶] or [◀] to select the [Display] menu.
3. Press [▼] to select [PBP].
4. Press [PBP] to enter the photo selection screen.
5. Press [▲] or [▼] or [◀] or [▶] to select the desired file for comparison.
6. Press [ENTER] to activate image comparison.
7. Press [▶] or [◀] to move through selected images.
8. Press [ZOOM+/-] to zoom in/out from the live image
9. Press [PBP] to return to the stored image screen.
10. Press [MENU] to exit.

7.16 Restoring Factory Default Settings (Factory Reset)

Use the remote control or control panel:

1. Press [MENU] on the **remote control** or **control panel** to enter the on-screen menu.
2. Press [▶] or [◀] to select the [Advance] menu.
3. Press [▼] to select [Factory Reset].
4. Press [▶] or [◀] to select [Yes].
5. Press [ENTER] to activate.

7.17 Computer- Related Functions

Ensure that the USB cable is connected and the drivers are installed before using the computer-related functions. Refer to [4.2.2 Connecting to external devices](#) and [4.4 Installing the driver and application B-Works in Chapter 4 Installation and Connections](#) in this user manual.

7.17.1 Inserting a Photo in the MS-Paint Application

1. Click [File> From Scanner or Camera] in the MS-Paint application as shown in the bottom left figure.

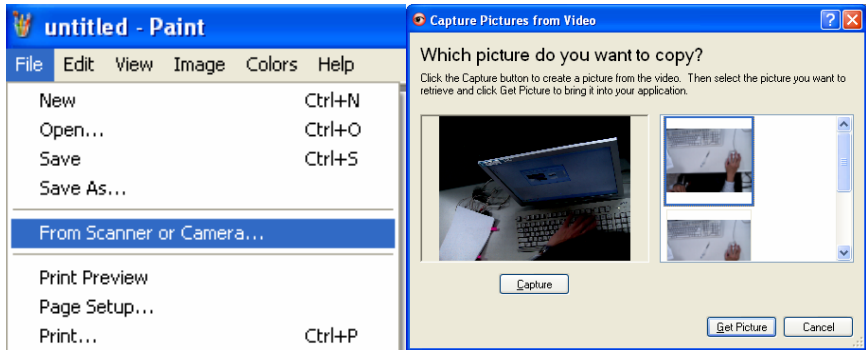

2. Click on [Get Picture] to finish, as shown in the top right figure.

7.17.2 Inserting a Photo in a Microsoft Word Document

1. Click [Insert / Image / From Scanner or Camera] in the Microsoft Word application.

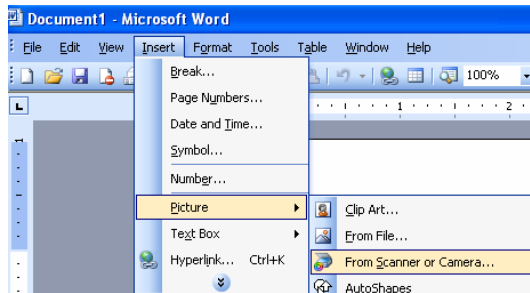

2. Select [Visual Presenter V2] and click [Custom Insert].



3. Click [Get Picture] to finish.

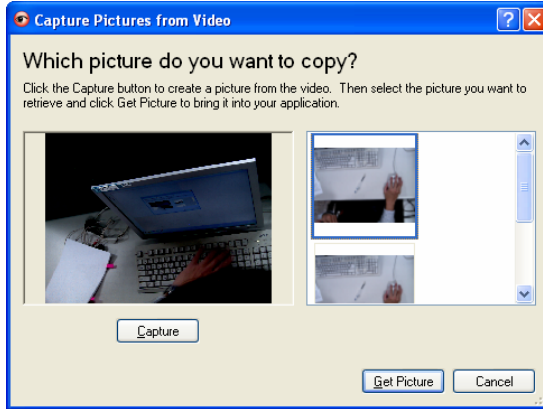

7.17.3 Changing the Setting of the Camera 335B and then Capturing a Photo in Microsoft Word

1. Click [Insert /Image /From Scanner or Camera] in **Microsoft Word**.

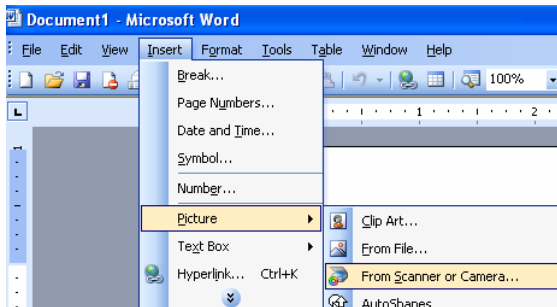

2. Select [Visual Presenter V2 TWAIN] and click [Custom Insert].



3. A window displaying a live image (see below) will appear.

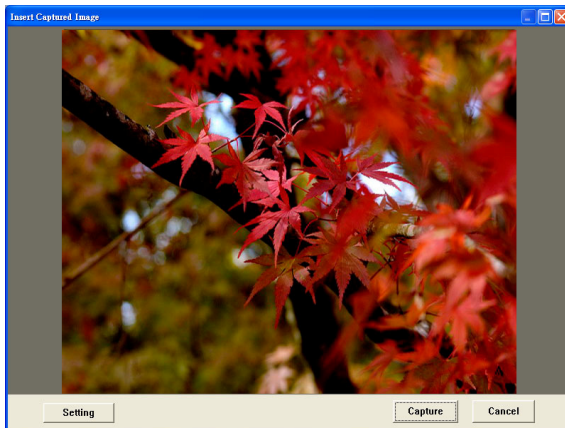

4. Press [Setting]: When the Camera Settings window pops up, the live image can be adjusted. The operation is identical from both the remote control and the control panel. Refer to [Chapter 6 Control Panel/Remote Control Buttons and On-screen Menu for more information](#).
5. Press [Capture] to capture images in **Microsoft Word**.
6. Press [Cancel] to exit.

7.17.4 Setting up the Camera 335B as a Webcam for Skype

The Camera 335B can be used as a webcam for instant message (IM) software such as **Skype** and **MSN**. Operation with any IM program is similar. In Skype, for example, complete the following steps:

1. Open the **Skype application** and choose [Tools] > [Options].
2. Select [Video Settings], check [Start my video automatically when I am in a call] and select [Visual Presenter V2] as the desired webcam, as shown below.

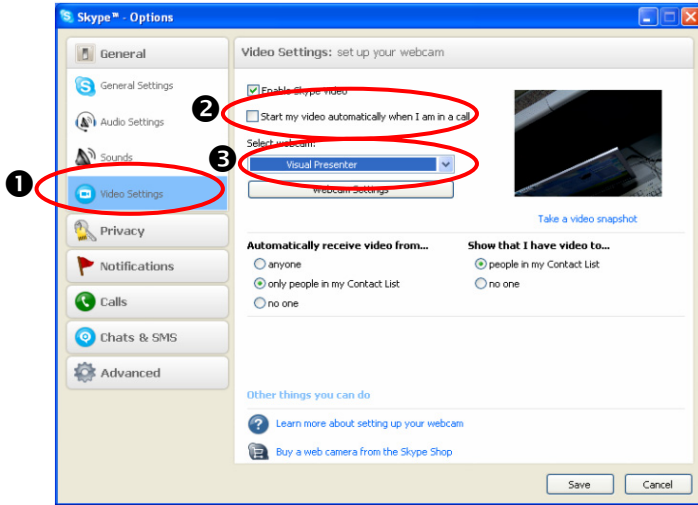

Call your desired contact. When both parties are connected, **Skype** will display the video screen.

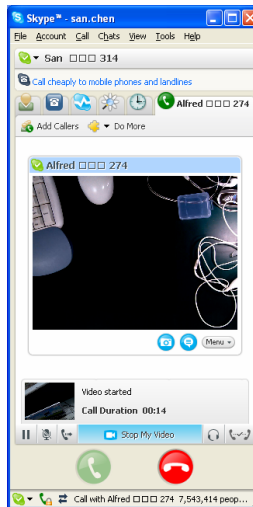

7.17.5 Setting the Camera 335B as a PC Camera

1. Open **My Computer** and click on [Visual Presenter V2] to display a live image.

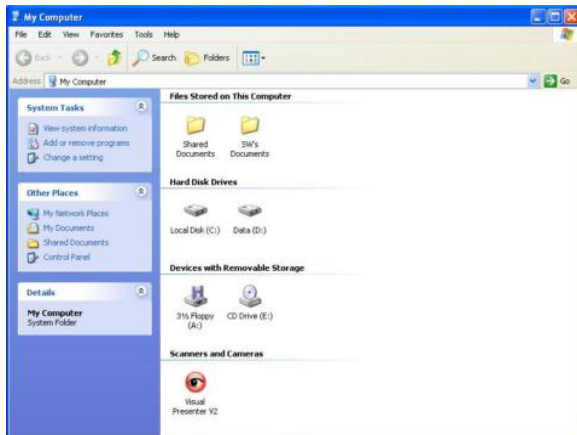

Chapter 8 Connecting to a Microscope

- 1 Mount the **microscope adaptor (optional)** in the accessories pack onto the microscope

<Note> The Microscope adaptor fits eyepieces of about Ø28.4mm.

- 2 Connect the lens of the Camera 335B to the **microscope adaptor**.

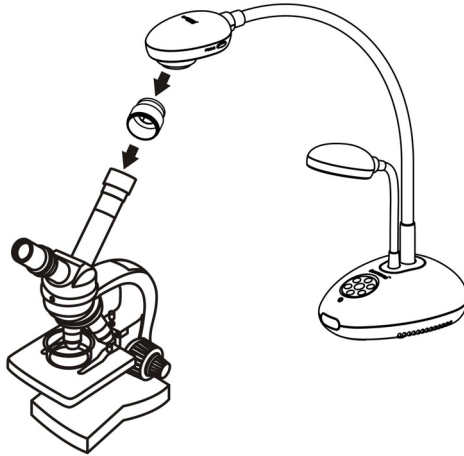

- 3 Select the Microscope mode

- 3.1. From the **control panel** or **remote control**

- 3.1.1. Press [MENU] to enter the on-screen menu.

- 3.1.2. Press [▶] or [◀] to select [Display].

- 3.1.3. Press [▼] to select among [Mode] modes.

- 3.1.4. Press [▶] or [◀] to select [Microscope].

- 4 If the image is fuzzy:

- 4.1. Adjust the focus of microscope.

- 4.2. Press the [FOCUS] button on either side of the Camera 335B lens to activate the auto focus.

Chapter 9 Software instructions

Using the Camera with a computer. After installing the **B-WORKS**, you can use the software to:

- Control the Camera 335B.
- Capture and record images.
- Annotate images, highlight important details and save them for later use.
- Use the full-screen function.

9.1 System Requirements

<i>Windows XP</i>	Windows Vista / Windows 7	MAC OS X 10.4 / 10.5 / 10.6 (32-bits Kernel)
<ul style="list-style-type: none">➤ Min CPU: P4 1.8 GHz➤ Min Memory: 512MB➤ Direct X 9 Compatible➤ Min Resolution: 1024x768➤ 100MB Min Disc Space	<ul style="list-style-type: none">➤ Min CPU: P4 2.4 GHz➤ Min Memory: 1GB (32-bits) /2GB(64-bits)➤ Direct X 9 Compatible➤ Min Resolution: 1024x768➤ 100MB Min Disc Space	<ul style="list-style-type: none">➤ Min CPU: PowerPC G4 866MHz or Intel Pentium®➤ 1.83GHz Intel Core 2 Duo➤ Min Memory: 512MB➤ Min resolution 1024x768➤ 24-bit color display monitor➤ 100MB Min Disc Space➤ Min QuickTime 7.4.5

9.2 Installation & Function

Please refer to the [B-WORKS](#) user manual in the CD for installation instructions and functions using.

Chapter 10 Troubleshooting

This chapter outlines possible solutions to common problems. For other issues, contact your dealer or service center.

No.	Problems	Solutions
1	No power signal	Check that the power cord is securely connected to the wall socket and the unit.
2	No image output from the Camera 335B	<ol style="list-style-type: none">1. Check the power outlet.2. Check the connection. Refer to 4.2.2 Connecting to external devices in Chapter 4 Installation and Connections in this manual.3. Check the signal sources [SOURCE]. Refer to 7.1 Switching image sources in Chapter 7 Descriptions of major functions in this manual.4. Check the settings for the projector source. Refer to the projector's user manual.5. Check if DIP Switch is properly set. Refer to Chapter 5 DIP Switch for related settings.
3	Unable to focus	Probably the document is too close to the lens. Press [ZOOM -] on the remote control or control panel . Or increase the distance between the lens and the document, and then press the [FOCUS] button on the right side of the lens.
4	Cannot see the entire image	Check Auto Image of the projector. Refer to the projector's user manual.
5	Visual Presenter V2, B-WORKS and other applications cannot be used simultaneously	Visual Presenter V2, B-WORKS and other applications cannot be used simultaneously. Please close the currently running applications and then execute the desired application.

Information in this Guide may change due to product improvements. To obtain the latest manuals, literature, and software please visit the Dukane web site at; www.dukane.com/av and look at the specific model SUPPORT or DOWNLOADS section.

DUKANE CORP AV SERVICE DEPT
2900 Dukane Drive
St Charles, IL 60174
800-676-2487 / 630-762-4032
Fax 630-584-5156
avservice@dukane.com
www.dukane.com/av